

Single-slot cradles



Single-slot charger kit

SKU# CRD-NGTC7-2SC1B

Single-slot charge-only ShareCradle kit. Charges a single TC73 / TC78 device and its spare Li-ion battery.

- Device with standard battery charges from 0–80% in about 1½ hours.
- Includes: Power supply SKU# PWR-BGA12V50W0WW, DC cable SKU# CBL-DC-388A1-01, and a shim SKU# SHIM-CRD-NGTC7.
- Sold separately: Country-specific AC line cord ([listed later in this document](#)).



Single-slot USB / Ethernet capable charger kit

SKU# CRD-NGTC7-2SE1B

Single-slot USB communication / ethernet capable charger ShareCradle kit. Charges a single TC73 / TC78 device and its spare Li-ion battery.

- Device with standard battery charges from 0–80% in about 1½ hours.
- Includes: Power supply SKU# PWR-BGA12V50W0WW and DC cable SKU# CBL-DC-388A1-01, and a shim SKU# SHIM-CRD-NGTC7.
- Sold separately: Country-specific AC line cord ([listed later in this document](#)), micro-USB cable SKU# 25-124330-01R for USB communication, and USB to Ethernet module kit SKU# MOD-MT2-EU1-01



USB to Ethernet module

SKU# MOD-MT2-EU1-01

Connects single-slot charge/USB charger to a local area network via Ethernet over USB.

- 10 / 100 / 1000 Mbps speed with LEDs on module to indicate connectivity and speed.
- Mechanical switch to choose micro-USB port or RJ45 Ethernet.



USB to Ethernet module kit

SKU# KT-TC51-ETH1-01

Connects single-slot charge / USB charger to a local area network via Ethernet over USB.

- 10 / 100 / 1000 Mbps speed with LEDs on module to indicate connectivity and speed.
- Mechanical switch to choose micro-USB port or RJ45 Ethernet.
- Includes: USB-Ethernet Module SKU# MOD-MT2-EU1-01 and support bracket SKU# BRKT-TC51-ENET1-01.

Multi-slot cradles



Five-slot charger kit

SKU# CRD-NGTC7-5SC5D

Charge-only ShareCradle kit to charge five TC73 / TC78 devices.

- Can be mounted in a standard 19-inch rack system using mounting bracket [SKU# BRKT-SCRD-SMRK-01](#).
- Device with standard battery charges from 0–80% in about 1½ hours.
- Includes: Power supply [SKU# PWR-BGA12V108W0WW](#), DC cable [SKU# CBL-DC-381A1-01](#), and 5-pack of a shim [SKU# SHIM-CRD-NGTC7](#)
- Sold separately: Country-specific AC line cord ([listed later in this document](#)).



Five-slot Ethernet charger kit

SKU# CRD-NGTC7-5SE5D

Five-slot charge / Ethernet ShareCradle kit. Charges five TC73 / TC78 devices with network speeds of up to 1 Gbps.

- Device with standard battery charges from 0–80% in about 1½ hours.
- Includes: Power supply [SKU# PWR-BGA12V108W0WW](#), DC cable [SKU# CBL-DC-381A1-01](#) and 5-pack of a shim [SKU# SHIM-CRD-NGTC7](#)
- Sold separately: Country-specific AC line cord ([listed later in this document](#)).



Five-slot charger kit

SKU# CRD-NGTC7-5SC4B

Charge-only ShareCradle kit to charge four TC73 / TC78 devices and four spare Li-ion batteries.

- Can be mounted in a standard 19-inch rack system using mounting bracket [SKU# BRKT-SCRD-SMRK-01](#).
- Device with standard battery charges from 0–80% in about 1½ hours.
- Includes: Power supply [SKU# PWR-BGA12V108W0WW](#), DC cable [SKU# CBL-DC-381A1-01](#), and four shims [SKU# SHIM-CRD-NGTC7](#)
- Sold separately: Country-specific AC line cord ([listed later in this document](#))

Cradle cups and a shim

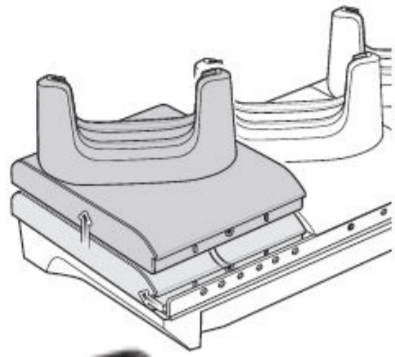

Device cradle cup replacement kit

SKU# CRDCUP-NGTC7-01

One TC73 / TC78 device cradle cup replacement kit. Can be used to replace a TC7x series device cup on ShareCradle when upgrading to TC73 / TC78.

- Includes: a shim [SKU# SHIM-CRD-NGTC7](#).
- [Also available as a 5-pack](#) — 5 device cradle cups and 5 inserts/a shim — [SKU# CRDCUP-NGTC7-05](#).

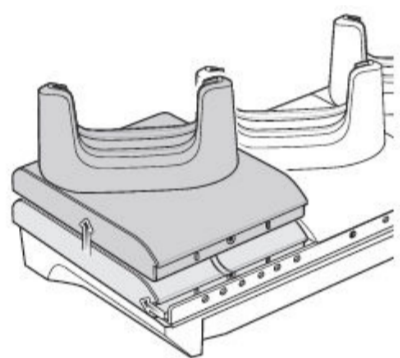

Charge and communication device cradle cup replacement kit

SKU# CRDCUP-NGTC7ETH-01

One TC73 / TC78 charge and USB / Ethernet connection device cradle cup replacement kit with two inserts/a shim.

- Can be used to replace a TC7x series device cup on ShareCradle when upgrading to TC73 / TC78.
- Includes: a shim [SKU# SHIM-CRD-NGTC7](#)
- [Also available as a 5-pack](#) — 5 device cradle cups and 10 inserts/a shim — [SKU# CRDCUP-NGTC7ETH-05](#).



Device cradle cup shim

SKU# SHIM-CRD-NGTC7

One black cradle cup shim

- Can be used to replace lost or damaged shims, or to swap legacy TC7x cradle cups for TC73/TC78 cups, that will also require [SKU# CRDCUP-NGTC7-01](#).

Zebra's intelligent cabinet portfolio

Optimize enterprise mobile device storage and management

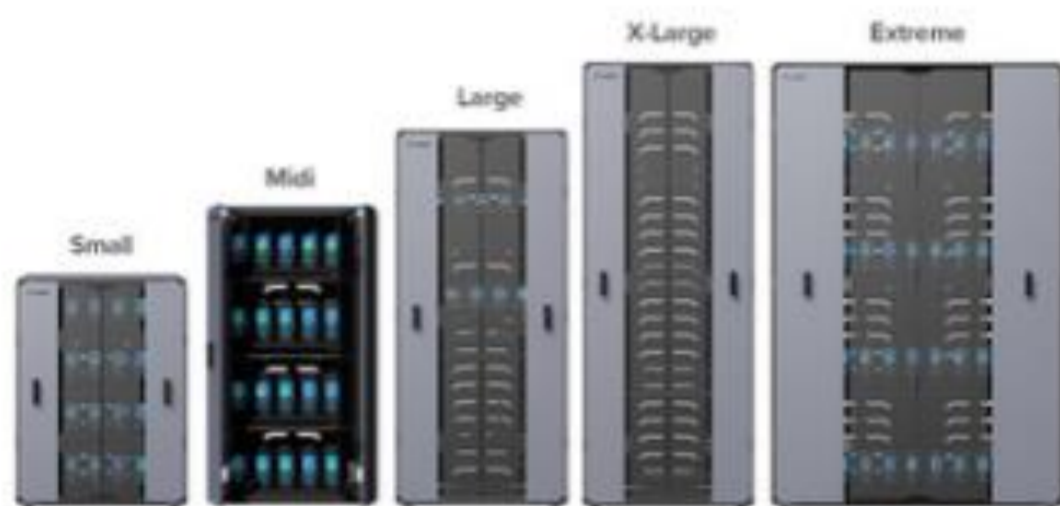

Intelligent Cabinets*

Easily secure, store, charge and handle checkout for Zebra mobile devices.

- Five cabinet sizes to accommodate between 20 and 100 devices
- Enhanced security options
- All-inclusive design includes built-in power supply
- Open leaf design for passive cooling through natural air flow

Cradle Locks

Easily add a layer of physical security in Intelligent Cabinets and racks with Zebra's cradle locks. Available for Zebra's HC2x, HC5x TC2x, TC5x and TC7x mobile computers, these mechanical locks physically prevent the removal of devices by any unauthorized personnel, increasing device security and reducing the number of lost or stolen devices.

- Mechanical locking for security and accountability
- Compatible with Zebra's Intelligent Racks and Cabinets.
- Battery charge status

Open Racks

Traditional open racks offer a durable industrial design

- A choice of single- or double-sided rack to meet capacity needs
- A choice of wheels to easily move the racks or feet to create stationary racks
- Offers integrated security options including cradle locks with PIN access

**Intelligent Cabinets are not be available in all regions.*

Refer to [Zebra Solutions Pathway](#) for detailed product information, product SKUs and pricing.

[Back to Table of Contents](#)

Mounting options for chargers



Rack mounting for space optimization

Optimize available space by mounting any set of five-slot chargers for TC7X on a standard, 19-inch server rack.

- Ideal for customers that have several devices per location.
- Compatible with all five-slot chargers



Mounting bracket

SKU# BRKT-SCRD-SMRK-01

Use five-slot ShareCradle mounting bracket to attach five-slot TC7X cradles to the wall or mount on a 19-inch server rack.

- Offers cable routing slots and removable tray that stores / conceals power supply.
- Adjustable orientations:
 - 25° angle for high-density (five-slot chargers).
 - Horizontal (single-slot or four-slot spare Li-ion charger).

Spare Li-ion batteries



BLE battery with PowerPrecision Plus

SKU# BTRY-NGTC5TC7-44MABLE-01

Standard capacity 4,680 mAh battery with PowerPrecision Plus and BLE beacon.

- BLE beacon allows device with this battery to be located even if powered off using [Zebra Device Tracker](#).
- Premium-grade battery cells with longer lifecycle and tested to meet rigorous controls and standards.
- Obtain advanced battery state of health information including charge level and battery age based on usage patterns.
- Sold separately: Zebra Device Tracker licenses for either 1-year SKU# SW-BLE-DT-SP-1YR or 3-years SKU# SW-BLE-DT-SP-3YR.



Standard battery with PowerPrecision Plus

SKU# BTRY-NGTC5TC7-44MA-01

- Robust housing for optimal performance and durability.
- Battery state of health features.

[Back to Table of Contents](#)

Spare Li-ion batteries



Extended capacity battery with PowerPrecision Plus

SKU# BTRY-NGTC5TC7-66MA-01

Extended capacity 7,000 mAh battery with PowerPrecision Plus.

- Premium-grade battery cells with longer lifecycle and tested to meet rigorous controls and standards.
- Obtain advanced battery state of health information including charge level and battery age based on usage patterns.



Wireless charging battery with PowerPrecision Plus

SKU# BTRY-NGTC5TC7-44MAWC-01

TC78 Standard capacity 4,680 mAh battery with Wireless charging and PowerPrecision Plus.

- Premium-grade battery cells with longer lifecycle and tested to meet rigorous controls and standards.
- Obtain advanced battery state of health information including charge level and battery age based on usage patterns.
- Works great with TC78 wireless charging vehicle cradle
SKU# CRD-TC78-WCVC-01.

Compatibility	
TC73	No
TC78	Yes



Standard battery with PowerPrecision Plus and Payment Support

SKU# BTRY-NGTC5TC7-PYMT

Standard capacity 4,680 mAh battery with PowerPrecision Plus and Payment support.

- Battery includes slot for integration with PD20 payment device.
- Premium-grade battery cells with longer lifecycle and tested to meet rigorous controls and standards.
- Obtain advanced battery state of health information including charge level and battery age based on usage patterns.

Spare Battery Charger



Battery charger

SKU# SAC-NGTC5TC7-4SCHG

Spare battery charger to charge any four spare Li-ion batteries.

- Standard capacity 4,400 mAh batteries charge from 0–90% in about 4 hours.
- Sold separately: Power Supply SKU# [PWR-BGA12V50W0WW](#), DC Cable SKU# [CBL-DC-388A1-01](#) and Country-specific AC Line cord ([listed later in this document](#)).



Battery charger kit

SKU# SAC-NGTC5TC7-4SCHG-01

Spare battery charger to charge any four spare Li-ion batteries.

- Standard capacity 4,680 mAh batteries charge from 0–90% in about 4 hours.
- Includes: : Power Supply SKU# [PWR-BGA12V50W0WW](#), DC Cable SKU# [CBL-DC-388A1-01](#)
- Sold separately: Country-specific AC Line cord ([listed later in this document](#)).



Four-slot battery charger conversion kit

SKU# BTRCUP-NGTC5TC7-01

One replacement four-slot battery charger

- Converts legacy TC5x four-slot battery charger or a multi-slot ShareCradle with spare battery Charger

Power supply, cables, and adapters

Power supply and cable matrix

SKU#	Description	Note
PWR-BGA12V108W0WW	Level VI AC/DC power supply brick. AC Input: 100–240V, 2.8A. DC Output: 12V, 9A, 108W.	Included in: <ul style="list-style-type: none"> • CRD-NGTC7-5SC5D • CRD-NGTC7-5SE5D • CRD-NGTC7-5SC4B
CBL-DC-381A1-01	DC line cord for running multi-slot cradles from a single Level VI power supply.	
PWR-BGA12V50W0WW	Level VI AC/DC power supply brick. AC Input: 100-240V, 2.4A. DC Output: 12V, 4.16A, 50W.	Included in: <ul style="list-style-type: none"> • CRD-NGTC7-2SC1B • CRD-NGTC7-2SE1B
CBL-DC-388A1-01	DC line cord for running single-slot cradles or battery chargers from a single Level VI power supply.	Sold separately. Use for SAC-NGTC5TC7-4SCHG.
CBL-TC5X-USBC2A-01	USB C to USB A communications and charging cable, 1m long	Sold separately. Use to: <ul style="list-style-type: none"> • Directly charge TC73 / TC78 using a wall wart. • Connect TC73 / TC78 to a computer (developer tools). • Charge TC73 / TC78 in a vehicle (can be used with cigarette light adapter SKU# CHG-AUTO-USB1-01, if needed).
CBL-TC2Y-USBC90A-01	USB C to USB A cable with 90° bend in USB-C adapter	
25-124330-01R	Micro USB active-sync cable. Allows for active-sync connectivity between the mobile computer single- or two-slot cradle and a host device.	Sold separately. Required for use with SKU# CRD-NGTC7-2SE1B if syncing with a computer is desired while TC73 / TC78 is in the charger.
CBL-DC-523A1-01	DC Y-line cord for running two spare battery chargers to a single Level VI power supply SKU# PWR-BGA12V108W0WW .	Sold separately. Use to: Consolidate power supplies for multiple spare battery chargers proximally placed to each other.
PWR-WUA5V12W0XX	USB type A power supply adapter (wall wart). Replace ‘XX’ in SKU as follows to get the right plug style based on region: US (United States) • GB (United Kingdom) • EU (European Union) AU (Australia) • CN (China) • IN (India) • KR (Korea) • BR (Brazil)	Sold separately. Use with a communications & charge cable to directly charge TC73 / TC78 device drawing power from a wall socket.

NOTE
Adapters and cables related to vehicle charging are listed later in this document.

Accessories that power devices















Power supply, cables, and adapters

Power supply and cable matrix

SKU#	Description	Note
CBL-TC2X-USBC-01	USB-A to USB-C cable with an additional ferrite bead.	
KIT-PWR-12V50W	Power supply kit including Power Supply SKU# PWR-BGA12V50W0WW and DC line cord SKU# CBL-DC-388A1-01 .	Sold Separately: Country-specific AC line cord.
CBL-DC-382A1-01	DC line cord for running five-slot cradles when using Level VI Efficiency power supply SKU# PWR-BGA12V108W0WW . Includes black extension tab for releasing the cable.	
CHG-AUTO-CLA1-01	Cigarette lighter auto charger for vehicle cradle SKU# CRD-TC78-WCVC-01 .	
CHG-AUTO-HWIRE1-01	Hard-wired auto charger cable for USB I / O Hub in vehicle cradle SKU# CRD-TC78-WCVC-01 .	Sold separately. Required for use with SKU# CRD-TC78-WCVC-01 to charge device.

Power supply, cables, and adapters

Country-specific AC line cords: grounded, 3-prong

SKU#	Country / region	Note	
23844-00-00R	North America (United States, Canada, Mexico)	7.5 feet long Commonly used with chargers mounted in server racks	
50-16000-678R	North America (United States, Canada, Mexico)	3 feet long	
50-16000-221R	North America (United States, Canada, Mexico)	6 feet long	
50-16000-727R	Brazil	1.8 meters (6 feet) long	
50-16000-680R	Argentina	1.8 meters (6 feet) long	
50-16000-217R	American Samoa, Australia, New Guinea	1.8 meters (6 feet) long	
50-16000-218R	Japan	1.8 meters (6 feet) long	
50-16000-219R	Antigua, Bermuda, Burma, Channel Islands, Hong Kong, Iraq, Ireland, Malaysia, North Ireland, Scotland, Singapore, United Kingdom, Wales	1.8 meters (6 feet) long	
50-16000-257R	China	1.8 meters (6 feet) long	
50-16000-220R	Europe, Abu Dhabi, Bolivia, Dubai, Egypt, Iran, Korea, Russia, Vietnam	1.8 meters (6 feet) long	
50-16000-671R	Italy	1.8 meters (6 feet) long	
50-16000-669R	India, S. Africa, Africa	1.8 meters (6 feet) long	

Accessories that power devices



Power supply, cables, and adapters

Country-specific AC line cords: ungrounded, 2-prong

SKU#	Country / region	Note
50-16000-182R	United States	Type A NEMA 1-15 plug
50-16000-255R	Europe, Abu Dhabi, Bolivia, Dubai, Egypt, Iran, Korea, Russia, Vietnam.	Type C CEE7/16 plug
50-16000-670R	Bermuda, England, Hong Kong, Iraq, Ireland, Malaysia, North Ireland, Scotland, Singapore, United Kingdom, Wales	
25-124330-01R	Cradle to USB cable Single slot cradle to PC/host USB cable. <ul style="list-style-type: none">• Used with single-slot cradle.• Micro-USB connection on cradle end	



Vehicle chargers and accessories



Wireless charger for use in vehicles

SKU# CRD-TC78-WCVC-01

TC78 Wireless charger for vehicles.

- Can be mounted using four AMPS-pattern holes.
- Includes a holder for stylus that can be installed either to the left or right of device in cradle or removed.
- Requires: TC78 device with wireless battery [SKU# BTRY-NGTC5TC7-44MAWC-01](#). All sold separately.
- Required to charge: Cigarette lighter adapter auto charge cable [SKU# CHG-AUTO-CKA1-01](#) OR hard-wired auto charge cable [SKU# CHG-AUTO-HWIRE1-01](#).
- For power and mounting options: see [Vehicle Holders and Mounts](#) listed later in this document.

Compatibility	
TC73	No
TC78	Yes



Vehicle holder

SKU# CRD-TC7NG-NCCD-01

Non-powered vehicle holder.

- Holds device in vehicle installations.
- Spring tension on holder, so does not support Pistol Grip Handle.
- Compatible with B and C size RAM® 2-hole diamond bases.
- Provides access to USB-C port on bottom of device allowing device to be charged.
- Available for mounting using [SKU# RAM-B-166U](#).

Compatibility	
TC73	Yes
TC78	Yes

NOTE

For mounting options and non-powered vehicle holders, please see section titled, "[Vehicle Holders and Mounts](#)", in this document.

For charging cables that can be used with vehicle holders, please see section titled, "[Power Supply, Cables, and Adapters](#)", in this document.

Accessories that enable productivity solutions



Vehicle holders and mounts



Cigarette lighter adapter plug

SKU# CHG-AUTO-USB1-01

USB cigarette lighter adapter plug.

- Used with USB Type C Cable SKU# CBL-TC5X-USBC2A-01 to charge device.
- Includes two USB Type A ports providing higher current (5V, 2.5A) for faster charging.



Vehicle mounting hardware

SKU# RAM-B-166U

Vehicle cradle windshield suction cup mount.

- RAM twist lock suction cup with double socket arm and diamond base adapter.
- Overall length: 6.75".
- Attaches to back of vehicle cradles.



Vehicle cradle mount ball

SKU# RAM-B-238U

Vehicle cradle RAM mount ball.

- RAM 2.43" x 1.31" diamond ball base with 1" ball.
- Attaches to back of vehicle cradles.

Accessories that enable productivity solutions



Headsets

Rugged Bluetooth HD voice headsets for the most demanding industrial environments

When it comes to enabling speech-driven applications and voice communications in warehouses, manufacturing plants and outdoor yards, you need a headset that is specially designed for the job. The HS3100 Bluetooth headset is loaded with features that offer everything you need in an industrial headset.

[Learn more about how these headsets deliver a superior voice experience.](#)



Wireless headsets for voice-directed picking HS3100 rugged Bluetooth headset

Bluetooth headset for voice-directed picking applications.

- Noise cancellation tuned for Voice-Directed Picking applications.
- Swap batteries on the fly — without losing the Bluetooth connection.
- Split-second tap-to-pair simplicity using NFC. 15 hours of battery power.

SKU#	Description
HS3100-OTH	HS3100 Rugged Bluetooth Headset Over-The-Head Headband includes HS3100 Boom Module and HSX100 OTH Headband Module
HS3100-BTN-L	HS3100 Rugged Bluetooth Headset (Behind-the-neck headband left)
HS3100-OTH-SB	HS3100 Rugged Bluetooth Headset (Over-the-head headband) includes HS3100 Shortened Boom Module and HSX100 OTH headband module
HS3100-BTN-LSB	HS3100 Rugged Bluetooth Headset (Behind-the-neck headband left) includes HS3100 Shortened Boom Module and HSX100 BTN headband module
HS3100-SBOOM-01	HS3100 Shortened Boom Module (includes microphone boom, battery and windscreen)

Close gaps, Open possibilities with Workforce Connect

Usher in a new era of transformation—one led by your frontline and powered by Zebra Workforce Connect. One where communication and information flows freely and gaps between teams, workflows and data are closed.

With Workforce Connect, hindered workers become effective problem solvers, contributing their best. Critical workflows are streamlined in one place, on one device, equipping workers with the information they need, right at their fingertips.

Only Zebra offers the most complete lineup of software and rugged hardware with the scalability, support and service needed to make the greatest impact where it counts—on the frontline.

[Learn more about you can elevate your frontline workers with Zebra Workforce Connect.](#)



Wired headset for Workforce Connect

SKU# [HDST-USBC-PTT1-01](#)

PTT headset with USB-C connector; one-piece solution.

- For Push-To-Talk (PTT) applications with volume up / volume down / PTT buttons. Compatible with PTT Express / PTT Pro.
- Rotating earpiece allows for right or left ear configuration. Mono headset with microphone.
- Includes clip for attaching PTT button to clothing.

Compatibility	
TC73	Yes
TC78	Yes

[Back to Table of Contents](#)

Hand strap, stylus and tether



Hand strap

SKU# SG-NGTC5TC7-HDSTP-01

Hand strap

- Allows device to be easily held in palm of hand.
- Attaches directly to device.
- Includes loop for holding optional stylus.
- Also available as a 3-pack — 3 hand straps— SKU# SG-NGTC5TC7-HDSTP-03.
- Also available as a 50-pack — 3 hand straps— SKU# SG-NGTC5TC7-HDSTP-50.
- Also available as a 100-pack — 3 hand straps— SKU# SG-NGTC5TC7-HDSTP-100.

** Please note this accessory is a consumable and may require replacement during the device's lifespan.*



Stylus

SKU# SG-STYLUS-TCX-MTL-03

Fiber tipped stylus – pack of 3.

- Heavy-duty and made from stainless steel / brass. No plastic parts — real pen feel. Can be used in rain.
- Micro-knit, hybrid-mesh, fiber tip provides silent, smooth gliding use. 5" length.
- Big improvement over rubber tipped or plastic tipped stylus.
- Compatible with all capacitive touch screen devices.
- Tether to device or hand strap using SKU# SG-TC5NGTC7NG-TETHR-03.

** Please note this accessory is a consumable and may require replacement during the device's lifespan.*



Stylus tether

SKU# SG-TC5NGTC7NG-TETHR-03

Stylus tether – pack of 3.

- Can be attached to device tower bar.
- When hand strap is used, tether should attach to hand strap SKU# SG-NGTC5TC7-HDSTP-03 directly (not to terminal towel bar).
- String type tether prevents loss of stylus.
- NOTE: Other Zebra coiled tethers are not recommended for use with TC73 / TC78 as they may interfere with other accessories.

** Please note this accessory is a consumable and may require replacement during the device's lifespan.*

Electronic trigger handles and accessories



Electronic trigger handle

SKU# TRG-NGTC7-ELEC-01

Pistol-grip trigger handle.

- Uses electrical trigger via contacts on back side of TC73 / TC78.
- Trigger handle accessory offers customers the option of using the product in a gun form factor, ideal for scan-intensive situations.
- Does not block access to rear facing camera and flash allowing camera to be used while using the trigger handle.
- Compatible with both standard and extended capacity batteries.
- Sold separately: Optional wrist strap [SKU# SG-PD40-WLD1-01](#).



Trigger handle wrist strap

SKU# SG-PD40-WLD1-01

Looping wrist strap for trigger handle.

- Attaches to bottom of pistol-grip trigger handle.

** Please note this accessory is a consumable and may require replacement during the device's lifespan.*

Soft holster, and screen protectors



Soft holster

SKU# SG-NGTC5TC7-HLSTR-01

Soft holster.

- Vertical orientation with open bucket design to accommodate TC73 / TC78 pistol-grip trigger handle, and/or hand strap.
- Strap on rear of holster allows adjustment for use with the accessory options mentioned above.
- Includes loop for storage of optional stylus. Nonrotating for maximum durability.
- Holster is leather material and includes cut-out for speaker output.
- Also compatible with trigger handle [SKU# TRG-NGTC7-ELEC-01](#) and hand strap [SKU# SG-NGTC5TC7-HDSTP-03](#).

** Please note this accessory is a consumable and may require replacement during the device's lifespan.*



Screen protectors

SKU# SG-NGTC7-SCRNP-03

Screen protector – pack of 3.

- Tempered glass.
- Includes alcohol wipes, cleaning cloth, and instructions needed for screen protector installation.

** Please note this accessory is a consumable and may require replacement during the device's lifespan.*

TC73 / TC78 Workstation Connect Cradle

Introducing the new **Workstation Connect Cradles** for TC73 / TC78 mobile computers. This accessory allows for the TC73 / TC78 mobile computer to connect to multiple purpose-built peripherals and enable Zebra Workstation Connect on an external monitor. The Connect Cradle offers connections for standard workstation setups (monitor, keyboard, mouse).



SKU# CRD-NTC7X-1SNWS-01

Workstation

- Workstation: TC73 / TC78 Connect Cradle, allows to connect a mobile computer to an external monitor and multiple peripherals. Includes HDMI, Ethernet and USB-A (x4) ports.



SKU# PWR-BGA12V50W0WW | SKU# CBL-DC-388A2-01

Power Supply | DC Line Cord

- Power Supply [PWR-BGA12V50W0WW](#) for Connect Cradle : 100-240 VAC, 12VDC, 4.16A.
- DC Line Cord [CBL-DC-388A2-01](#) for above power supply: 12 VDC, 4.16A 1.8m length.